

# DrayTek

## VigorSwitch P1092

PoE Smart Lite Giga Switch



### Quick Start Guide

V1.0

# VigorSwitch P1092

## PoE Smart Lite Giga Switch

### Quick Start Guide

Version: 1.0

Firmware Version: V1.01.03

(For future update, please visit [DrayTek web site](#))

Date: December 26, 2017

## Intellectual Property Rights (IPR) Information

### Copyrights

© All rights reserved. This publication contains information that is protected by copyright. No part may be reproduced, transmitted, transcribed, stored in a retrieval system, or translated into any language without written permission from the copyright holders.

### Trademarks

The following trademarks are used in this document:

- Microsoft is a registered trademark of Microsoft Corp.
- Windows, Windows 95, 98, Me, NT, 2000, XP, Vista, 7, 8 and Explorer are trademarks of Microsoft Corp.
- Apple and Mac OS are registered trademarks of Apple Inc.
- Other products may be trademarks or registered trademarks of their respective manufacturers.

## Safety Instructions and Approval

### Safety

#### Instructions

- Read the installation guide thoroughly before you set up the router.
- The router is a complicated electronic unit that may be repaired only by authorized and qualified personnel. Do not try to open or repair the router yourself.
- Do not place the router in a damp or humid place, e.g. a bathroom.
- Do not stack the routers.
- The router should be used in a sheltered area, within a temperature range of +5 to +40 Celsius.
- Do not expose the router to direct sunlight or other heat sources. The housing and electronic components may be damaged by direct sunlight or heat sources.
- Do not deploy the cable for LAN connection outdoor to prevent electronic shock hazards.
- Keep the package out of reach of children.
- When you want to dispose of the router, please follow local regulations on conservation of the environment.

### Warranty

We warrant to the original end user (purchaser) that the router will be free from any defects in workmanship or materials for a period of one (1) year from the date of purchase from the dealer. Please keep your purchase receipt in a safe place as it serves as proof of date of purchase. During the warranty period, and upon proof of purchase, should the product have indications of failure due to faulty workmanship and/or materials, we will, at our discretion, repair or replace the defective products or components, without charge for either parts or labor, to whatever extent we deem necessary to restore the product to proper operating condition. Any replacement will consist of a new or re-manufactured functionally equivalent product of equal value, and will be offered solely at our discretion. This warranty will not apply if the product is modified, misused, tampered with, damaged by an act of God, or subjected to abnormal working conditions. The warranty does not cover the bundled or licensed software of other vendors. Defects which do not significantly affect the usability of the product will not be covered by the warranty. We reserve the right to revise the manual and online documentation and to make changes from time to time in the contents hereof without obligation to notify any person of such revision or changes.



## EU Declaration of Conformity

We DrayTek Corp. , office at No.26, Fu Shing Road, HuKou County, Hsin-Chu Industry Park, Hsinchu 300, Taiwan , R.O.C., declare under our sole responsibility that the product

- **Product name:** PoE Smart Lite Giga Switch
- **Model number:** VigorSwitch P1092
- **Manufacturer:** DrayTek Corp.
- **Address:** No.26, Fu Shing Road, HuKou County, Hsin-Chu Industry Park, Hsinchu 300, Taiwan , R.O.C.

is in conformity with the relevant Union harmonisation legislation:

EMC Directive 2014/30/EU , Low Voltage Directive 2014/35/EU and RoHS 2011/65/EU with reference to the following standards

Standard	Version / Issue date
EN 55032	2015 Class A
EN 61000-3-2	2014 Class A
EN 61000-3-3	2013
EN 55024	2010+A1:2015
EN 60950-1	2006 +A11:2009 +A1:2010 +A12:2011+ A2:2013

Hsinchu  
(place)

22nd June, 2017  
(date)

*Calvin Ma*  
Calvin Ma / President  
(Legal Signature)

## Regulatory Information

### Federal Communication Commission Interference Statement

This equipment has been tested and found to comply with the limits for a Class A digital device, pursuant to Part 15 of the FCC Rules. These limits are designed to provide reasonable protection against harmful interference in a residential installation. This equipment generates, uses and can radiate radio frequency energy and, if not installed and used in accordance with the instructions, may cause harmful interference to radio communications. However, there is no guarantee that interference will not occur in a particular installation. If this equipment does cause harmful interference to radio or television reception, which can be determined by turning the equipment off and on, the user is encouraged to try to correct the interference by one of the following measures:

- Reorient or relocate the receiving antenna.
- Increase the separation between the equipment and receiver.
- Connect the equipment into an outlet on a circuit different from that to which the receiver is connected.
- Consult the dealer or an experienced radio/TV technician for help.

This device complies with Part 15 of the FCC Rules. Operation is subject to the following two conditions:

- (1) This device may not cause harmful interference, and
- (2) This device may accept any interference received, including interference that may cause undesired operation.

Caution: Any changes or modifications not expressly approved by the party responsible for compliance could void the user's authority to operate the equipment.



More update, please visit [www.draytek.com](http://www.draytek.com).

## Be a Registered Owner

Web registration is preferred. You can register your Vigor router via <http://www.draytek.com>.

## Firmware & Tools Updates

Due to the continuous evolution of DrayTek technology, all routers will be regularly upgraded. Please consult the DrayTek web site for more information on newest firmware, tools and documents. <http://www.draytek.com>

# 1

## Package Content

The 8 ports, PoE Smart Lite Giga Switch is a standard switch that meets both IEEE 802.3u/ab Fast Ethernet and Gigabit Ethernet specifications.

The network administrator can logon the switch to monitor, configure and control each port's activity. In addition, the switch implements the QoS (Quality of Service) and VLAN. It is suitable for office application.



**VigorSwitch**

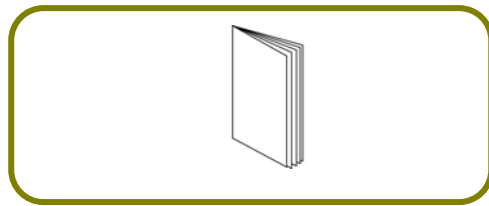

**Quick Start Guide**

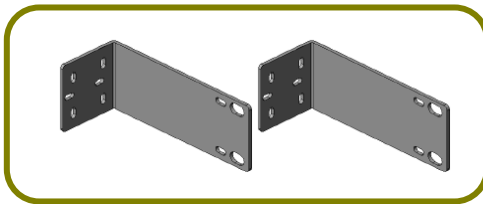

**Rack Mount Kit (brackets)**

The type of the power cord depends on the country that the router will be installed.



**UK-type Power Cord**



**EU-type Power Cord**

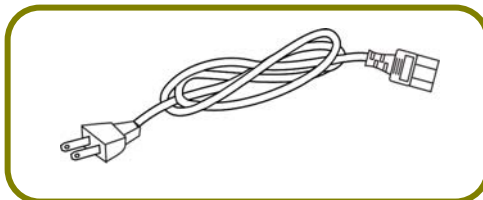

**USA/Taiwan-type Power Cord**

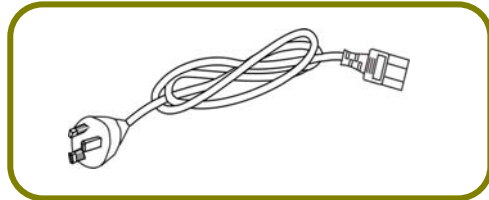

**AU/NZ-type Power Cord**

If any of these items is found missing or damaged, please contact your local supplier for replacement.

# 2

## Panel Explanation

RJ45 LNK/ACT Port 1 to Port 8 / PoE for Port 1 to Port 8

SFP LNK/ACT

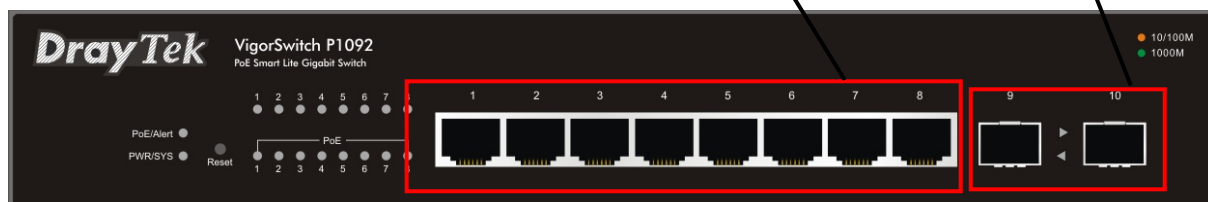

LED	Status	Explanation
PoE/Alert	On (Green)	Connected over the PoE maximum power budget.
	Off	Connected within the PoE maximum power budget.
PWR/SYS	On (Green)	The switch is powered on and runs normally.
	Off	The switch is not ready or is failed.
PoE for Ports 1~8	On (Green)	The port is supplied with PoE power.
	Off	No PoE power is supplied on the port.
RJ 45 LNK/ACT for Ports 1 ~ 8	On (Green)	The device is connected with 1000Mbps.
	On (Amber)	The device is connected with 10/100Mbps.
	Blinking	The system is sending or receiving data through the port.
	Off	The port is disconnected or the link is failed.



Interface	Description
RJ 45 LNK/ACT Port 1 ~ 8 PoE for Port 1 ~ 8	Port 1 to Port 8 can be used for Ethernet connection and PoE connection, depending on the device connected.
SFP Port 9 ~ 10	Used for fiber connection.
	Power inlet for AC input (100~240V/AC, 50/60Hz).



**Note**

Power Output --

- IEEE 802.3af Max. 15.4W Output Supported
- IEEE 802.3at Max. 30W Output Supported

PoE Power Budget --

- 110 Watts (Max)

# 3

## Hardware Installation

This section will guide you to install the router through hardware connection and configure the router's settings through web browser.

Before starting to configure the router, you have to connect your devices correctly.



Note

Power the device to this switch and get 48V power source through Cat. 5e Cable.

### 3.1 Network Connection

- Use a Cat. 5e twisted-pair cable to connect a PoE device to the port (1-8) of this switch.
- The switch will supply power to PoE Device over the twisted-pair cable.
- Please note that Power Device must comply with IEEE 802.3af/at.
- Other PCs, servers and network devices can be connected to the switch using a standard 'straight through' twisted pair cable.

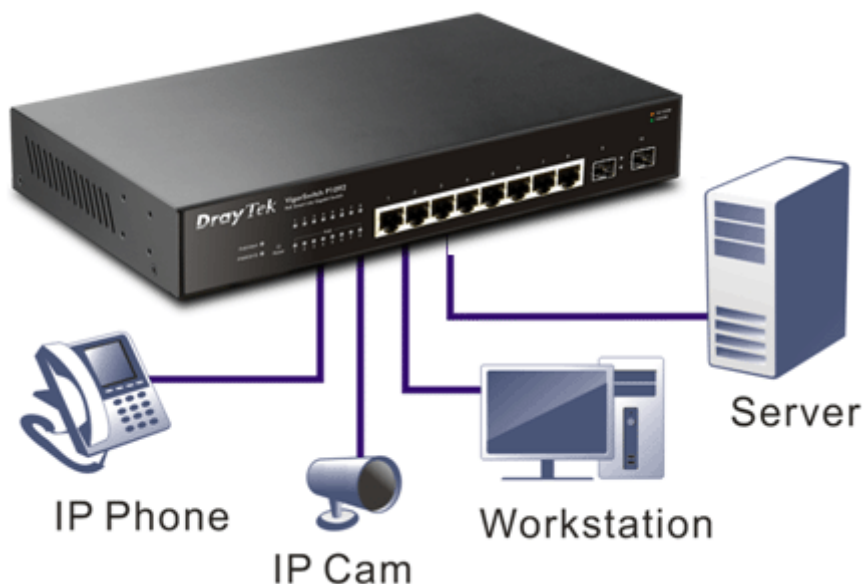

## 3.2 Wall-Mounted Installation

The switch can be easily installed using a rack mount kit.

1. Attach the brackets to the chassis of a 19- or a 23-inch rack. The second bracket attaches the other side of the chassis as above procedure.

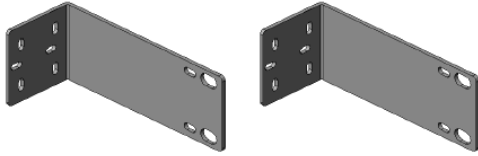

2. After the bracket installation, the VigorSwitch's chassis can be installed in a rack by using four screws for each side of the rack.

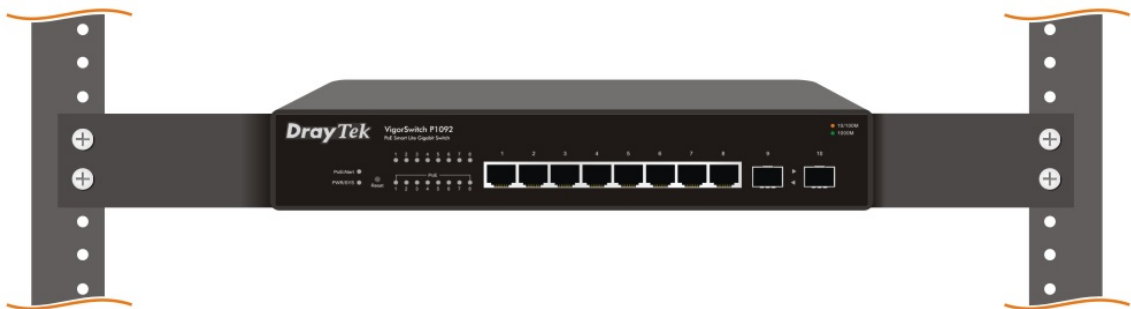

# 4

## Software Configuration

VigorSwitch, for example:  
IP Address: 192.168.1.224  
Subnet Mask: 255.255.255.0  
Default Gateway: 192.168.1.254

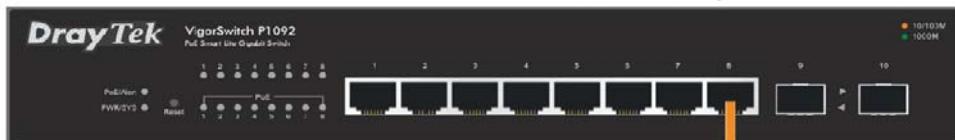

Assign a reasonable IP Address, for example:  
IP Address: 192.168.1.100  
Subnet Mask: 255.255.255.0  
Default Gateway: 192.168.1.254



Ethernet LAN

Before using the switch, perform the following steps:

1. Set up a physical path between the configured the switch and a PC by a qualified UTP Cat. 5e cable with RJ-45 connector.

If a PC directly connects to the switch, you have to setup the same subnet mask for PC and the switch. Default values of the managed switch are listed as follows:

IP Address	192.168.1.224
Subnet Mask	255.255.255.0
DHCP Client	Enabled (On)
Password	admin

2. After configuring correct IP address on your PC, open your web browser and access switch's IP address.

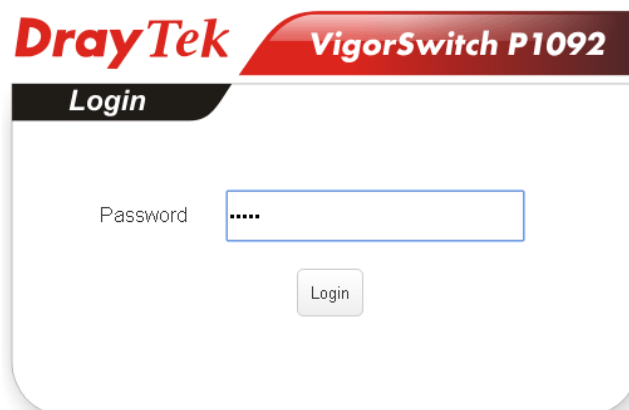

The home page of VigorSwitch will be shown as below:



## Customer Service

If the router cannot work correctly after trying many efforts, please contact your dealer for further help right away. For any questions, please feel free to send e-mail to support@draytek.com.

### GPL Notice

This DrayTek product uses software partially or completely licensed under the terms of the GNU GENERAL PUBLIC LICENSE. The author of the software does not provide any warranty. A Limited Warranty is offered on DrayTek products. This Limited Warranty does not cover any software applications or programs.

To download source codes please visit:

<http://gplsource.draytek.com>

GNU GENERAL PUBLIC LICENSE:

<https://gnu.org/licenses/gpl-2.0>

Version 2, June 1991

For any question, please feel free to contact DrayTek technical support at support@draytek.com for further information.